

BLHO

# Giardini

—

# Sadržaj

—

- 1** Kontekst
- 2** Koncept
- 3** Giardini
- 4** Trg 1
- 5** Trg 2
- 6** Zone lokala
- 7** Zona arheologije
- 8** Laginjina
- 9** Prostorni prikazi

# Kontekst

—









# Obodni sadržaji



- 1 Palazzo della Banca d'Italia, 1937.god.
- 2-4 stambeno-poslovne građevine
- 5 stambeno-poslovna građevina, Slastičarnica Giardini
- 6-8 stambeno-poslovne građevine
- 9 "staro kino", Caffè bar Cookie
- 10-13 stambeno-poslovne građevine
- 14 stambeno-poslovna građevina, Caffè bar Mate
- 15 stambeno-poslovna građevina, Zlatna Vrata
- 16-20 stambeno-poslovne građevine
- 21 poslovna građevina
- 22 stambena građevina
- 23 stambeno-poslovna građevina, Caffè club Glam, Kino Valli
- 24 Kuća Heiningera, Ottomar Heiningera 1935. – 1937., Caffè bar Bolero, Caffè bar Corso, Caffè bar Rustico
- 25 stambeno-poslovna građevina
- A Slavoluk Sergijevaca
- B Gradske zidine
- C Istarsko narodno kazalište



# Obodni sadržaji

—



Slavoluk Sergijevaca

—

Zgrada palače banke

—

Kino Valli

—

Kuća Heiningera



# Obodni sadržaji

—



Centralna ljekarna

—

Kino Beograd

—

Gradske zidine

—

Istarsko narodno kazalište



# Analiza promet



- ..... cestovni promet jačeg inteziteta
- ..... javni cestovni promet, autobusna linija
- ..... cestovni promet slabijeg inteziteta - dostava, interventna vozila, vozila s dozvolom
- cestovne barijere
- × kraj cestovnog prometa
- P promet u mirovanju
- pješačka zona
- BUS stanica javnog prijevoza

# Urbani život Giardina



- 1 Slastičarnica Giardini/ pripadajuća terasa:  
a: P= 26m<sup>2</sup>
- 2 Caffè bar Cookie/ pripadajuća terasa:  
f: P= 46m<sup>2</sup>
- 3 Caffè bar Mate/ pripadajuće terase:  
i: P= 53m<sup>2</sup>  
j: P= 26m<sup>2</sup>  
k: P= 36m<sup>2</sup>
- 4 Caffè club Glam/ pripadajuće terase:  
g: P=57m<sup>2</sup>  
h: P= 80m<sup>2</sup>
- 5 Caffè bar Bolero/ pripadajuće terase:  
d: P= 49m<sup>2</sup>
- 6 Caffè bar Rustico/ pripadajuće terase:  
e: P= 56m<sup>2</sup>
- 7 Caffè bar Corso/ pripadajuće terase:  
b: P=120m<sup>2</sup>  
c: P= 79m<sup>2</sup>

# Lokali



# Urbana oprema

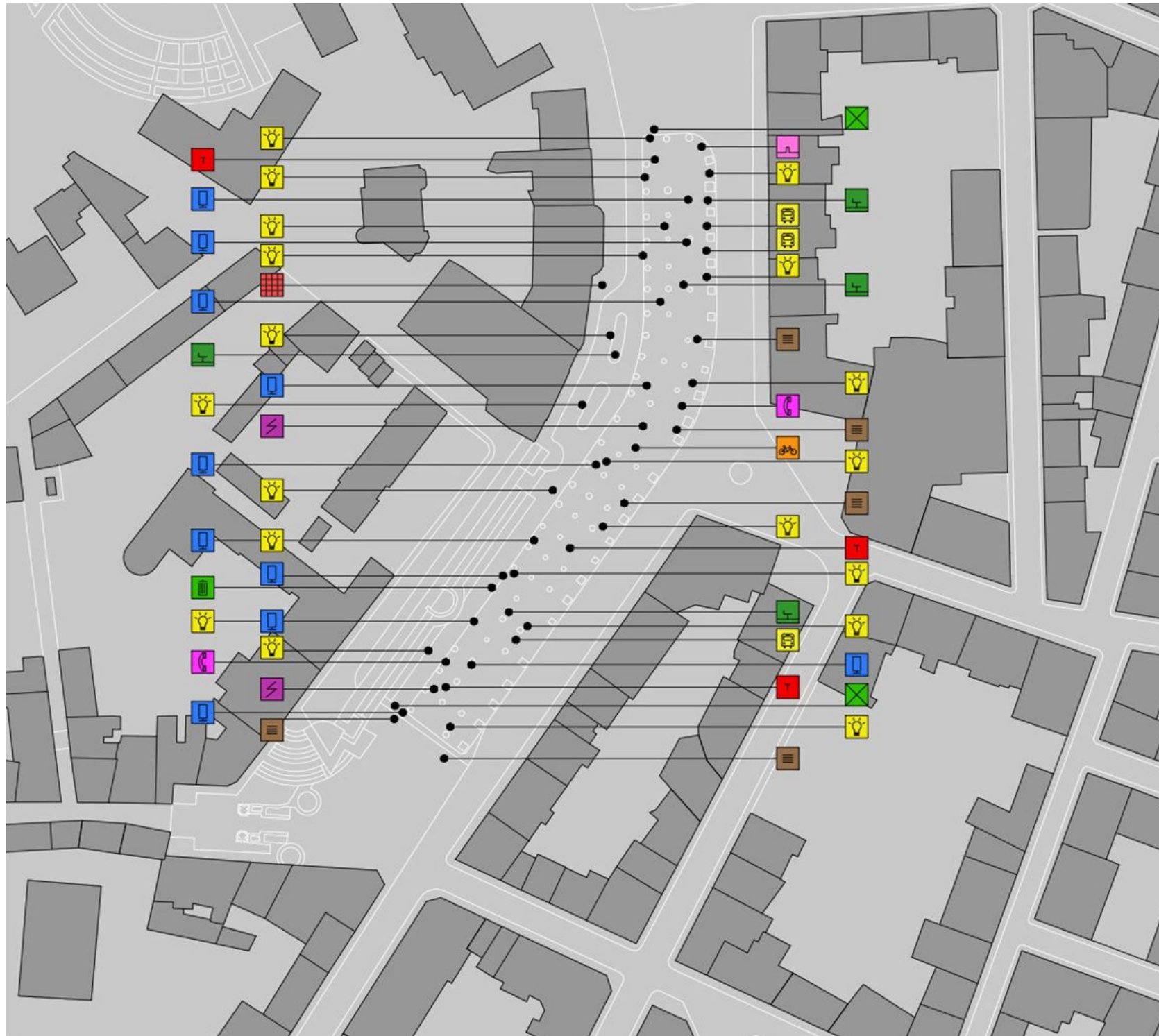

-  oglasni/ reklamni pano
-  imitacija povijesnog opločenja/  
crvene klinker pločice
-  javna rasvjeta
-  ormar za struju
-  klupa
-  telefonska govornica
-  otpad
-  kiosk
-  stanica javnog prometa
-  cestovne barijere
-  odvodnja
-  stalci za bicikle/ bičikleta
-  Tisak
-  podzemni kontejneri
-  rubnjaci oko stabla

# Urbana oprema

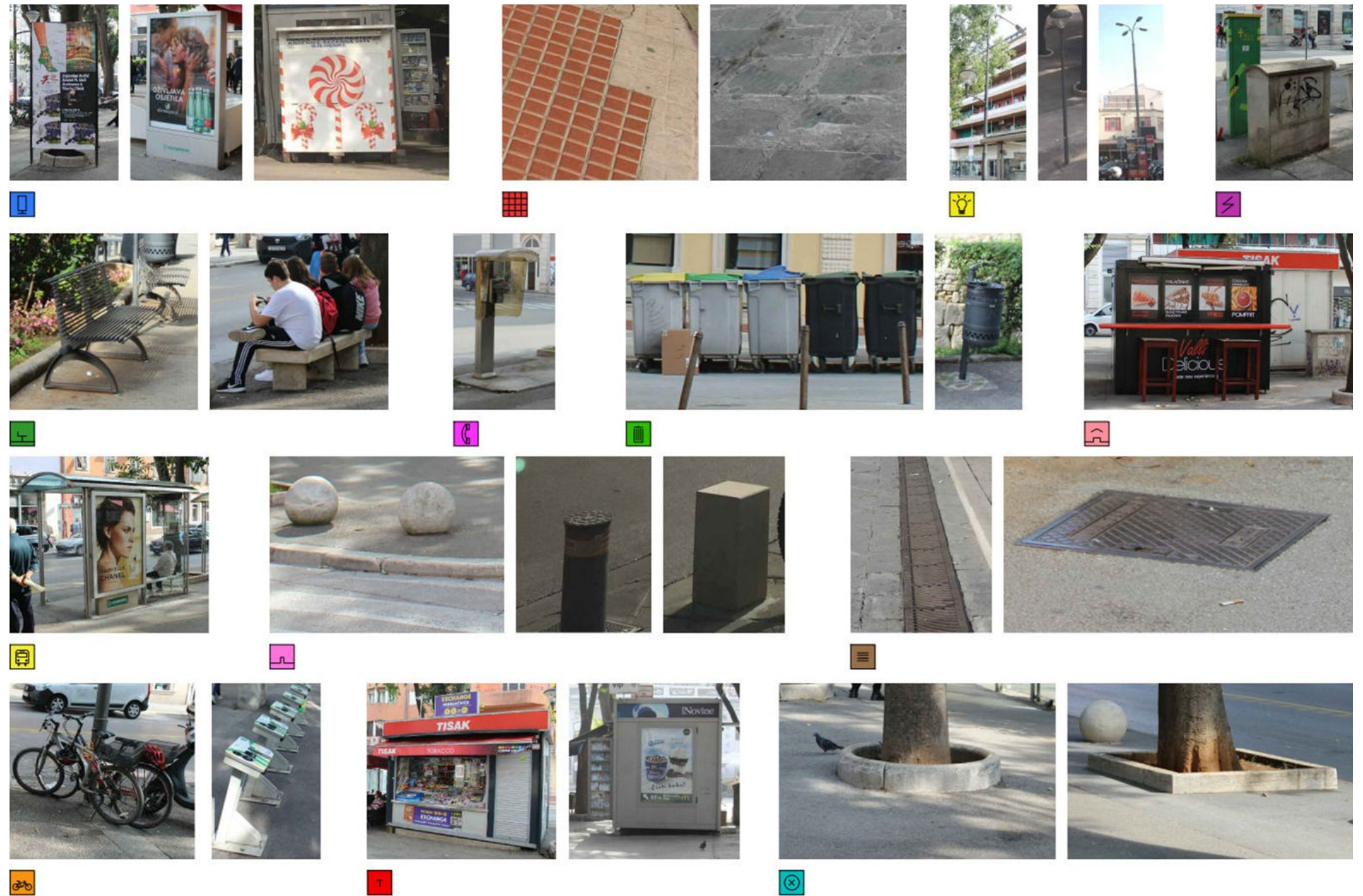

# Urbana oprema

—





# Urbana oprema

—



# Urbana oprema

—



# Pula film festival



- 1 Arena
- 2 Kino Valli
- 3 Kaštel
- 4 INK/ Istarsko narodno kazalište
- 5 Titov park
- 6 Circolo - Zajednica Talijana
- 7 Portarata
- 8 Gradska knjižnica i čitaonica Pula
- 9 Galerija Makina
- 10 MMC Luka
- 11 SKUC/ Srpski kulturni centar u Istri
- 12 Giardini
- 13 HGK/ Hrvatska gospodarska komora
- 14 MSUI/ Muzej suvremene umjetnosti Istre
- 15 Plaža Ambrela

# Pula film festival



# Zelenilo



# Zelenilo



● Postojeća stabla

*Ladonja (Celtis australis L.)*, je bjelogorično stablo koje može narasti 20-25 metara visine. Lišće: Jednostavno, izmjenično, oštro nazubljeno, grubo na vršcima, ima dlačice s donje strane, 5 do 15 cm dužine i tamnosivo/zeleno tijekom sezone, blijedi do svijetložute boje prije nego što otpadne u jesen. Cvjetovi: cvjetovi su hermafroditski (imaju muške i ženske organe), mali, zeleni, bez latica, pojedinačni ili u malim nakupinama. Plodovi: Male, tamnoljubičaste bobice (koštunice) Kora: Glatka, siva kora razvija slikovite plutaste bradavice i kvrge u starijoj dobi. Pogoduju joj kisela, neutralna i lužnata (alkalna) tla. Podnosi suha i vlažna tla i može tolerirati sušu. Mediteranska klima joj posebno pogoduje.

○ stabla koja nedostaju u povijesno zasađenom četveroredu

# Giardini

—



# Geneza

—

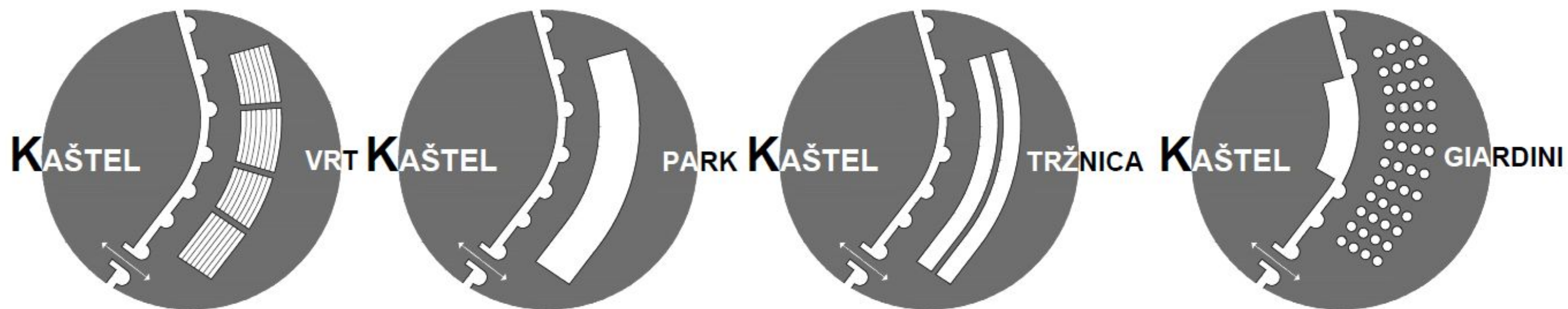



# Povijesne fotografije

—  
1908. godine



# Povijesne fotografije

—  
1910. godine



# Povijesne fotografije

—  
1920. godine



# Povijesne fotografije

—  
1937. godine



# Analiza oploćenja



- staro rimsko popločenje
- 01 Rasparaganov uspon
- 02 Uspon Svetog Roka
- 03 Uspon P. Đakona
- 04 Uspon Konzula Istranina
- 05 Uspon Svetog F. Asiškog
- 06 Uspon Vincenta iz Kastva
- 07 De Villeov uspon - novoobnovljeno s novim materijalom
- 08 Cvečićev uspon
- 09 Uspon F. Glavinića
- staro rimsko popločenje  
- pretpostavka prethodnog popločenja,  
danas prekriveno slojem asfalta
- 10 Castropola ulica
- kamen peščenjak
- 11 Kandlerova ulica - staro popločenje
- 12 Trg Svetog Tome - staro popločenje, samo pločnik
- 13 Kapitolinski trg - staro popločenje
- 14 Forum - novoobnovljeno postojeće popločenje
- 15 Kapitolinski trg - novoobnovljeno postojeće popločenje
- 16 Maksimijanova ulica - novoobnovljeno postojeće popločenje
- 17 Kazališni prolaz - staro popločenje
- 18 Ulica M. Držića - staro popločenje
- 19 Trg Portarata - novo popločenje
- kamen peščenjak  
- pretpostavka prethodnog popločenja,  
danas prekriveno slojem asfalta
- 20 Ulica Sergijevaca
- 21 Danteov trg
- asfalt
- zelena površina

# Analiza opločenja

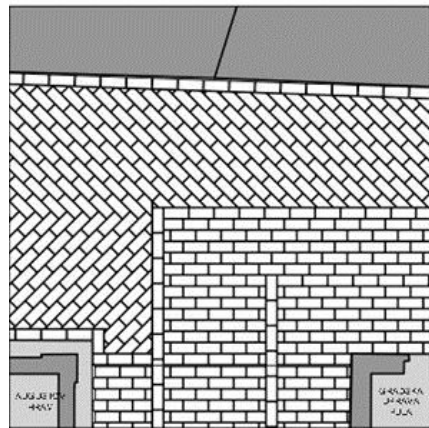



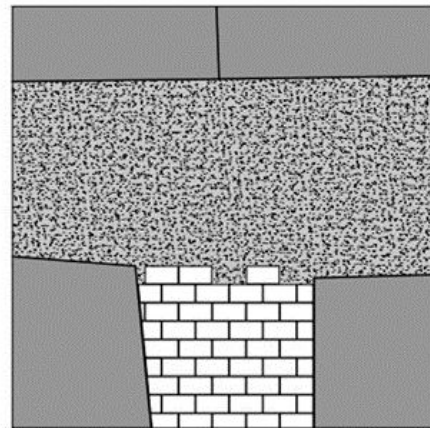

KAPITOLINSKI TRG

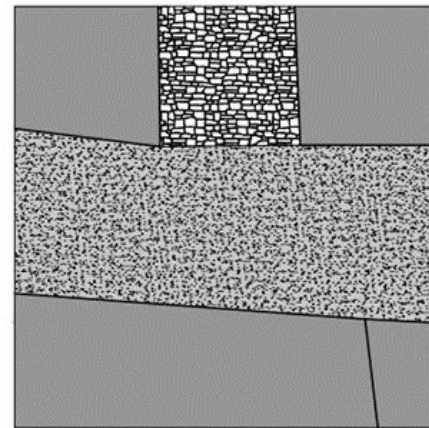

ULICA SERGIJEVACA / PROLAZ KOD KAZALIŠTA



ULICA SERGIJEVACA / CVEČIČEV PROLAZ

-  staro rimsko popločenje
-  kamen peščenjak (polaganje na posmik)
-  kamen peščenjak (riblja kost)
-  kamen peščenjak (pravilan raster)
-  asfalt

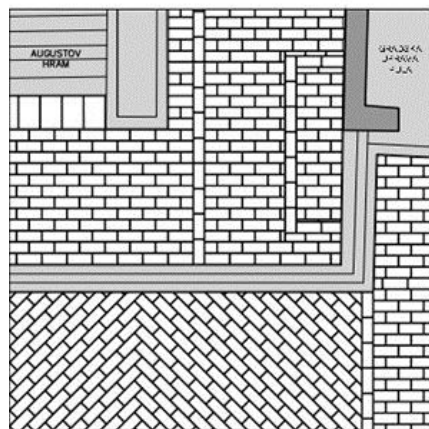

FORUM

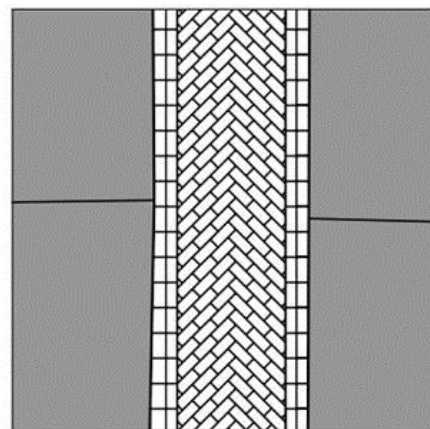

MAKSIMIJANOVA ULICA

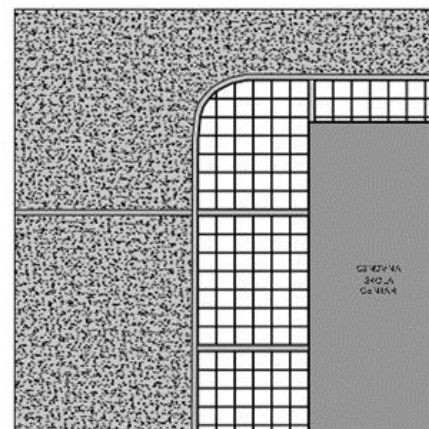

DANTEOV TRG (2011)

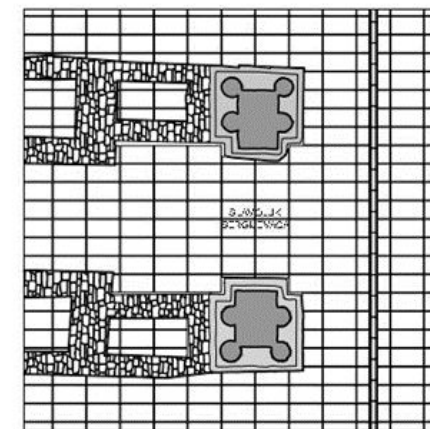

TRG PORTARATA / ULICA SERGIJEVACA

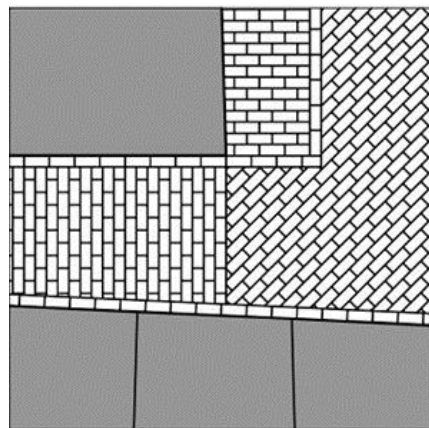

AUGUSTOV PROLAZ / FORUM

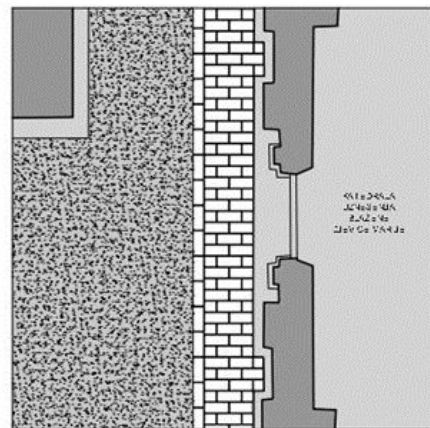

TRG SV. TOME

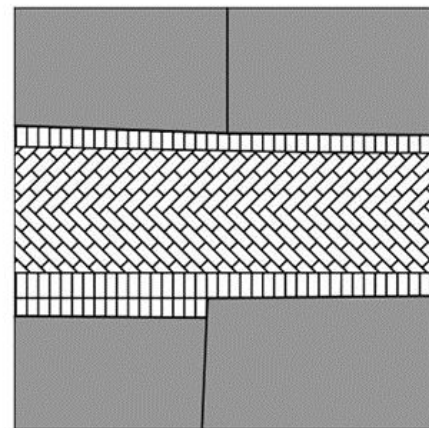

KANDLEROVA ULICA

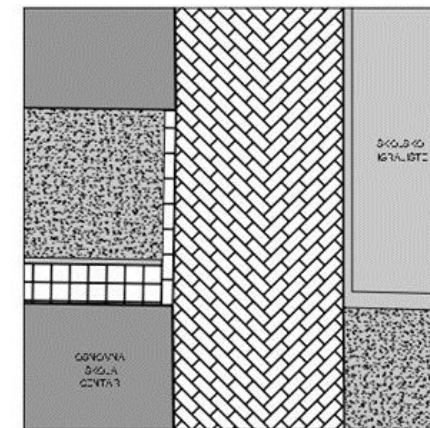

ULICA H. DALMATINA / ULICA M.DRŽIČA

# Bijeli i sivi kamen

—

*Bijeli akcenti*  
(podest Augustovog hrama,  
Gradske vijećnice, tragovi  
bedema, zgrada Fine) unutar  
sivog neutralnog tkiva  
(tranzitne ulice i zone).



# Afirmacija

—

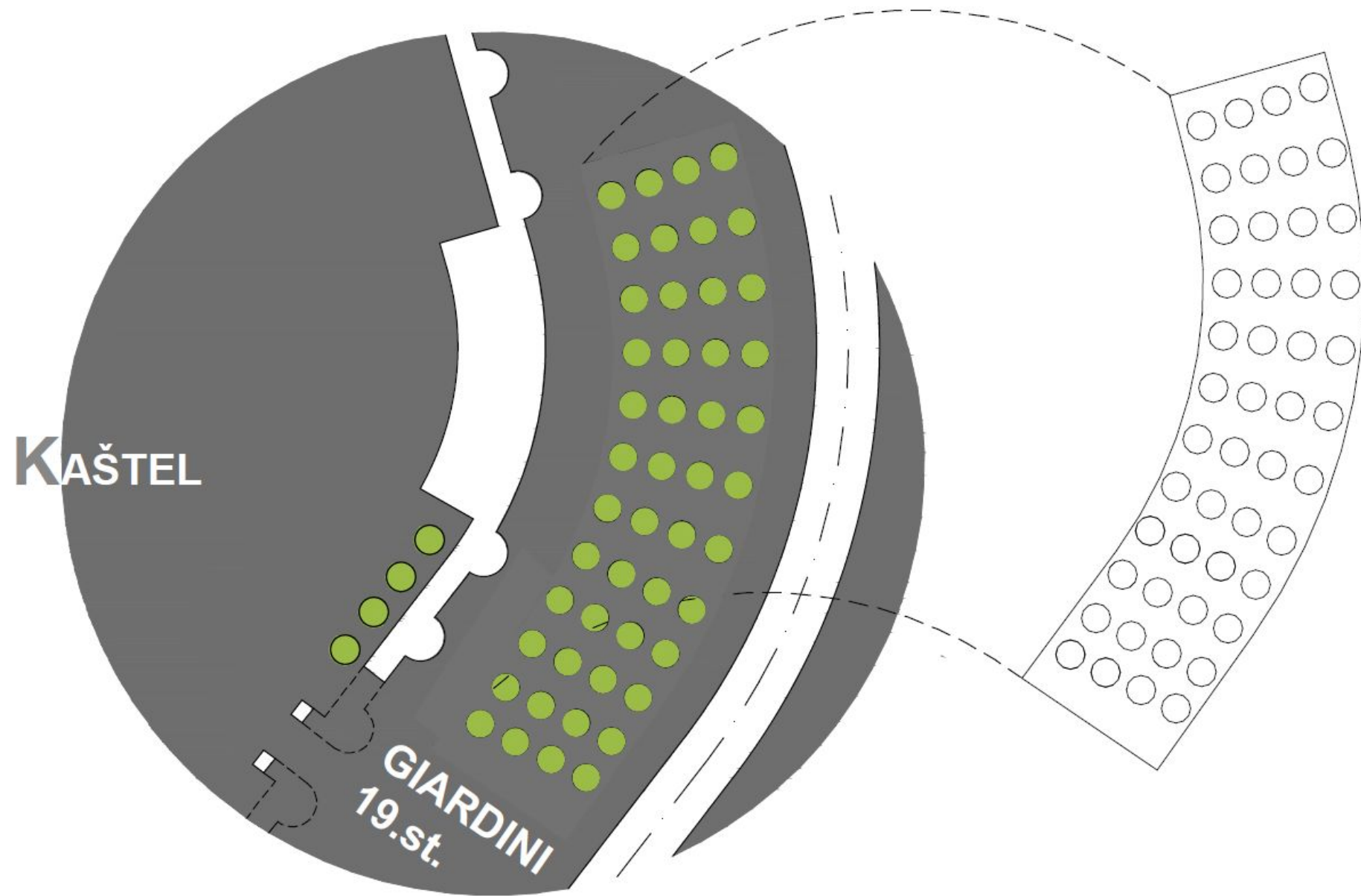



# Kamen

—

Bijeli kamen  
- Giardini

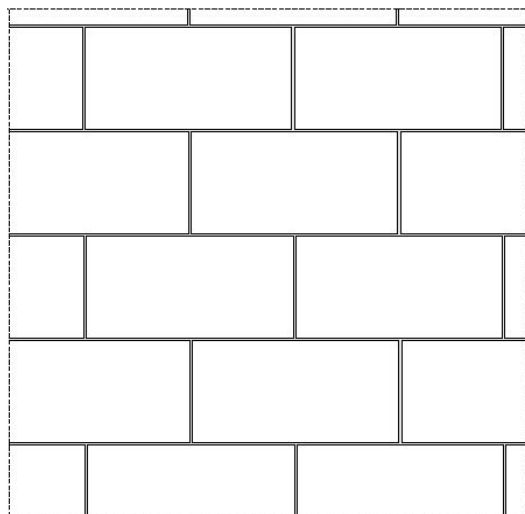

Sivi kamen  
- okolna zona

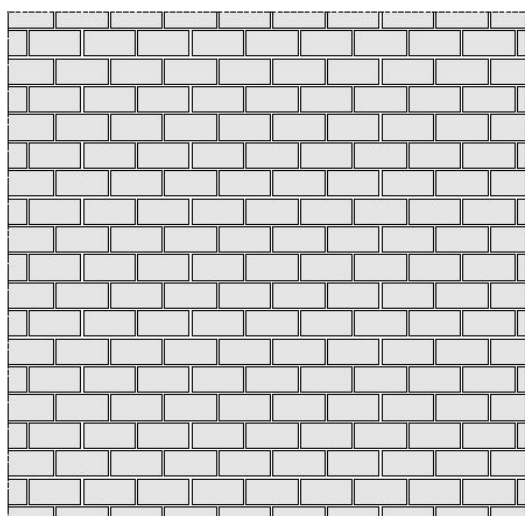

BLHO

# Giardini

—

# Prikaz izdizanja



Izdizanje Giardina za jednu stubu  
kontinuirana visina stube za sve  
četiri strane

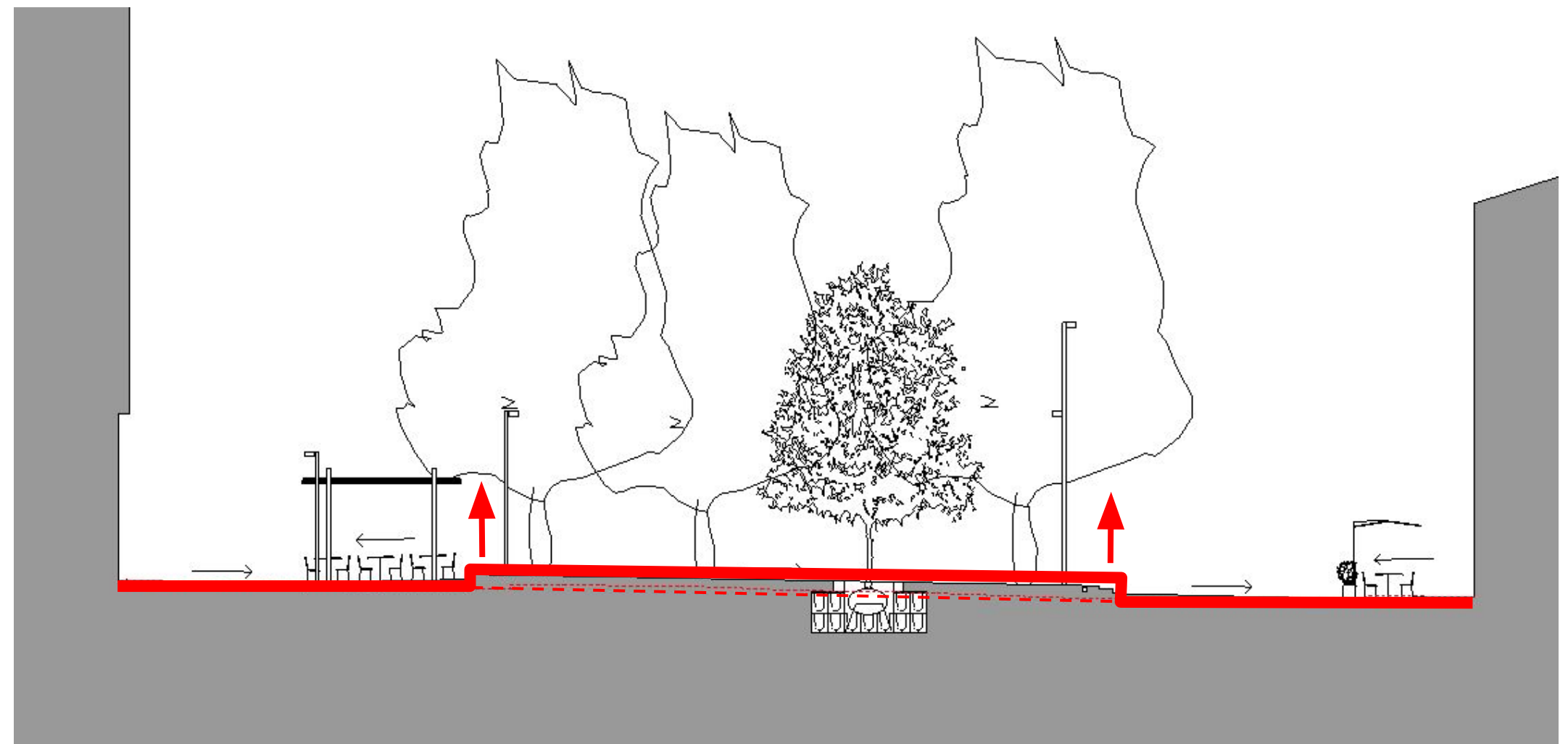

# Rekonstrukcija četveroreda

—  
Četverored - zeleni tepih  
*vraćanje originalnog broja ladanja*

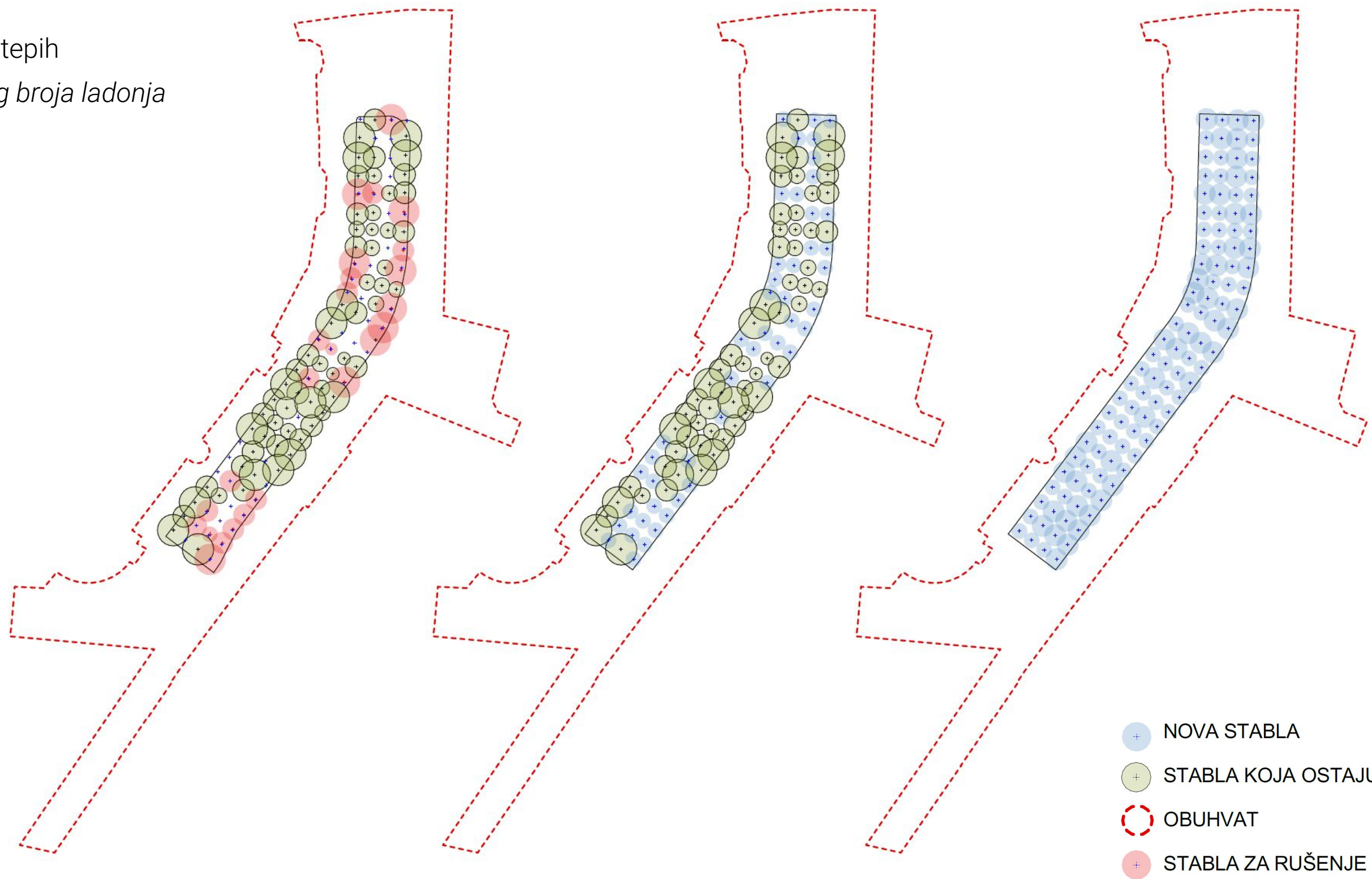

# Detalj sadnje novih stabala

—

Sustav sadnje u Rootspacere, sa sustavom navodnjavanja i zračnih kanala

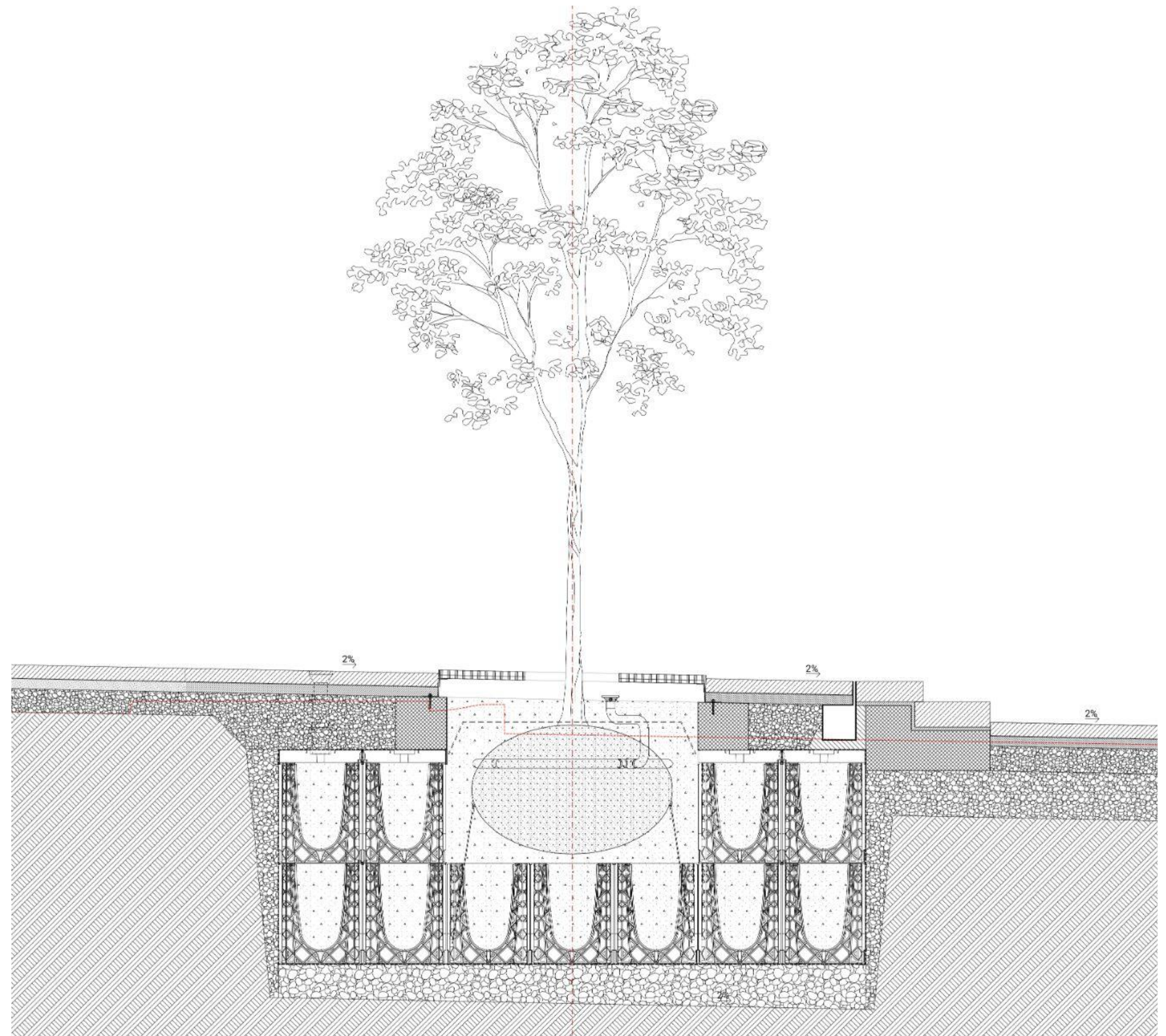

# Atmosfera

—

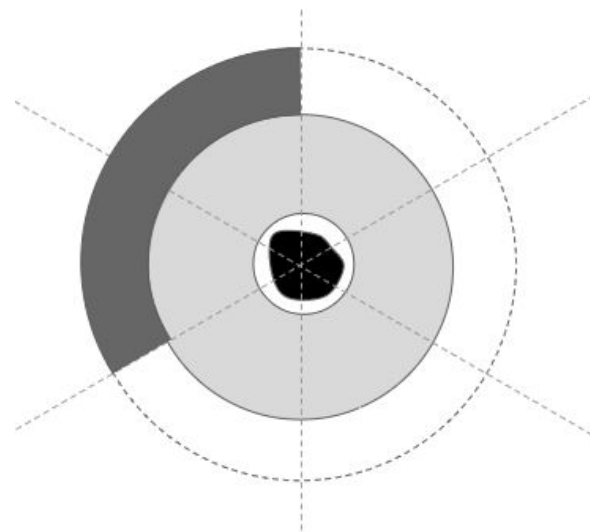
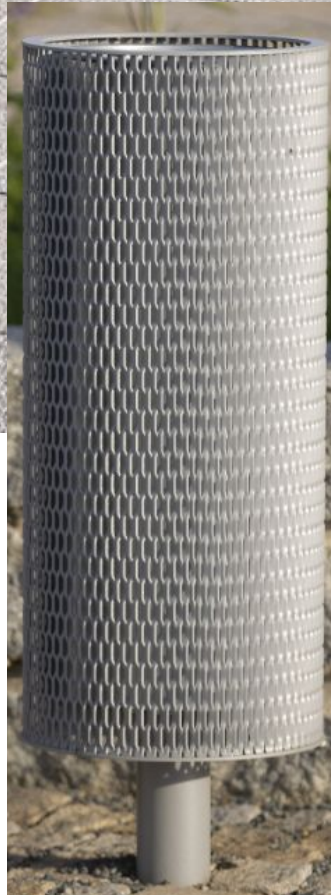

# Rešetka oko novo zasadenog stabla

—

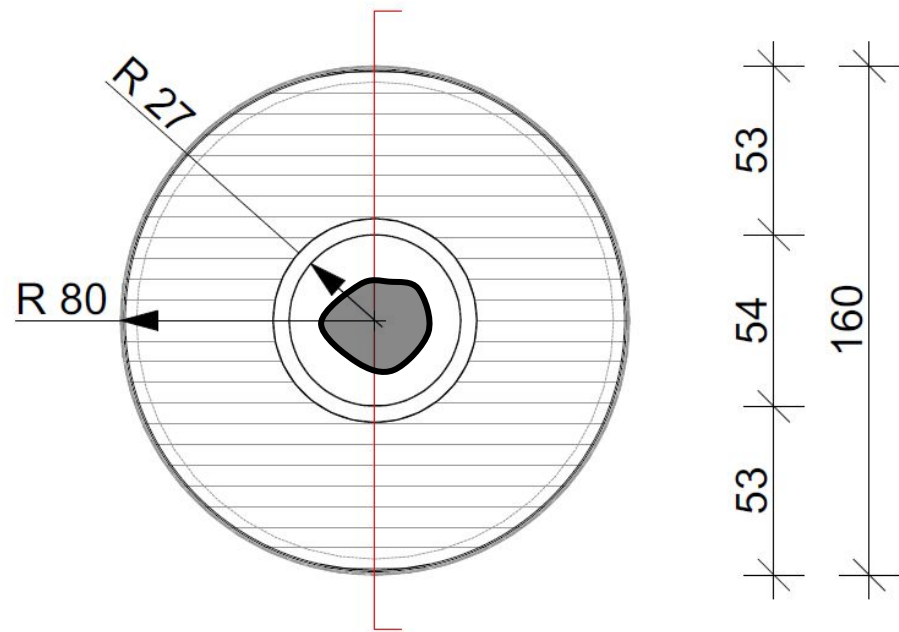
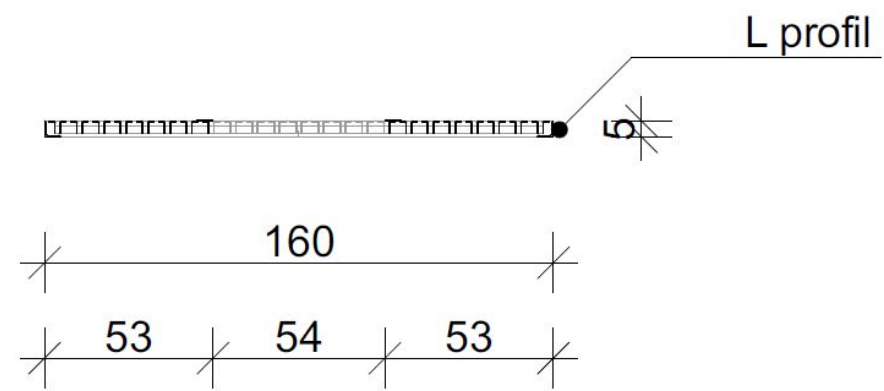

# Klupa

—

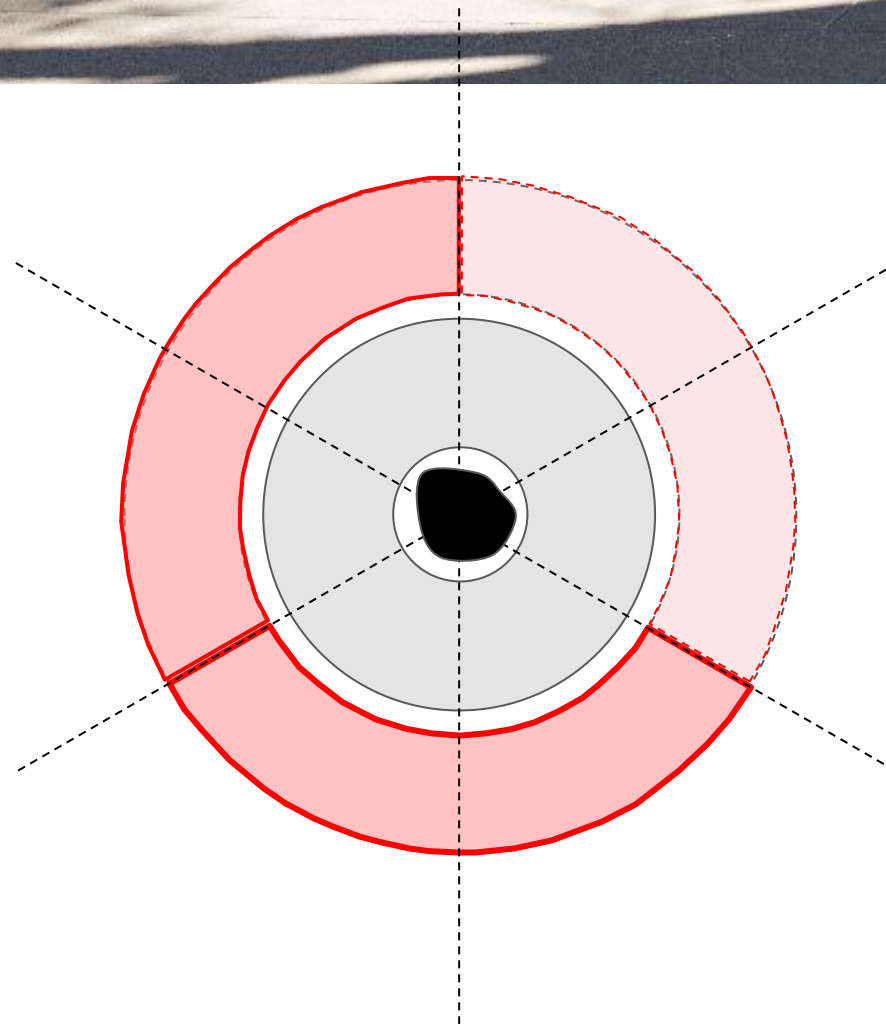
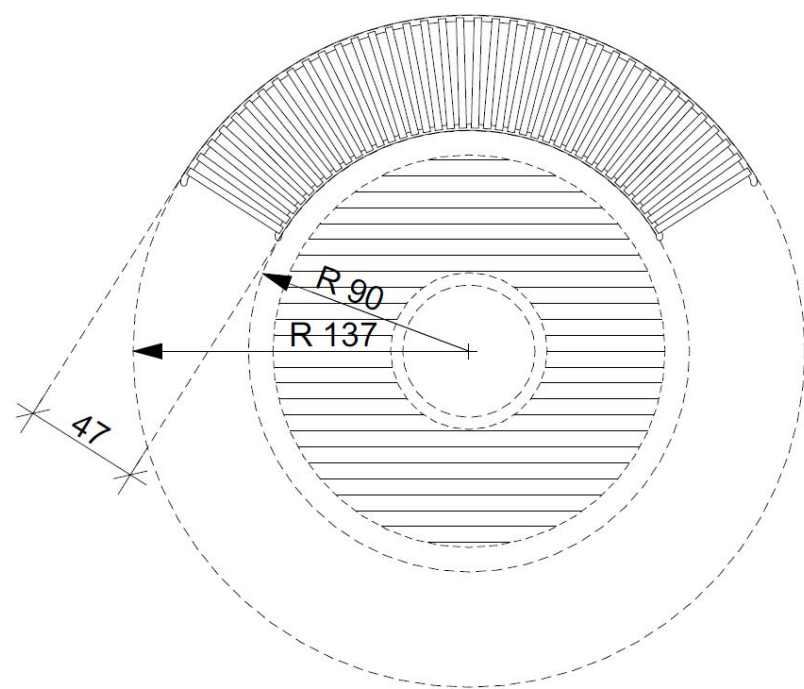
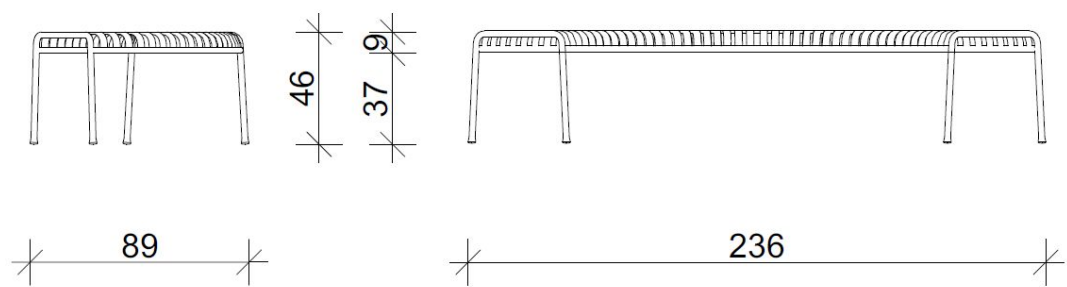



# Rasvjetni stupovi

—

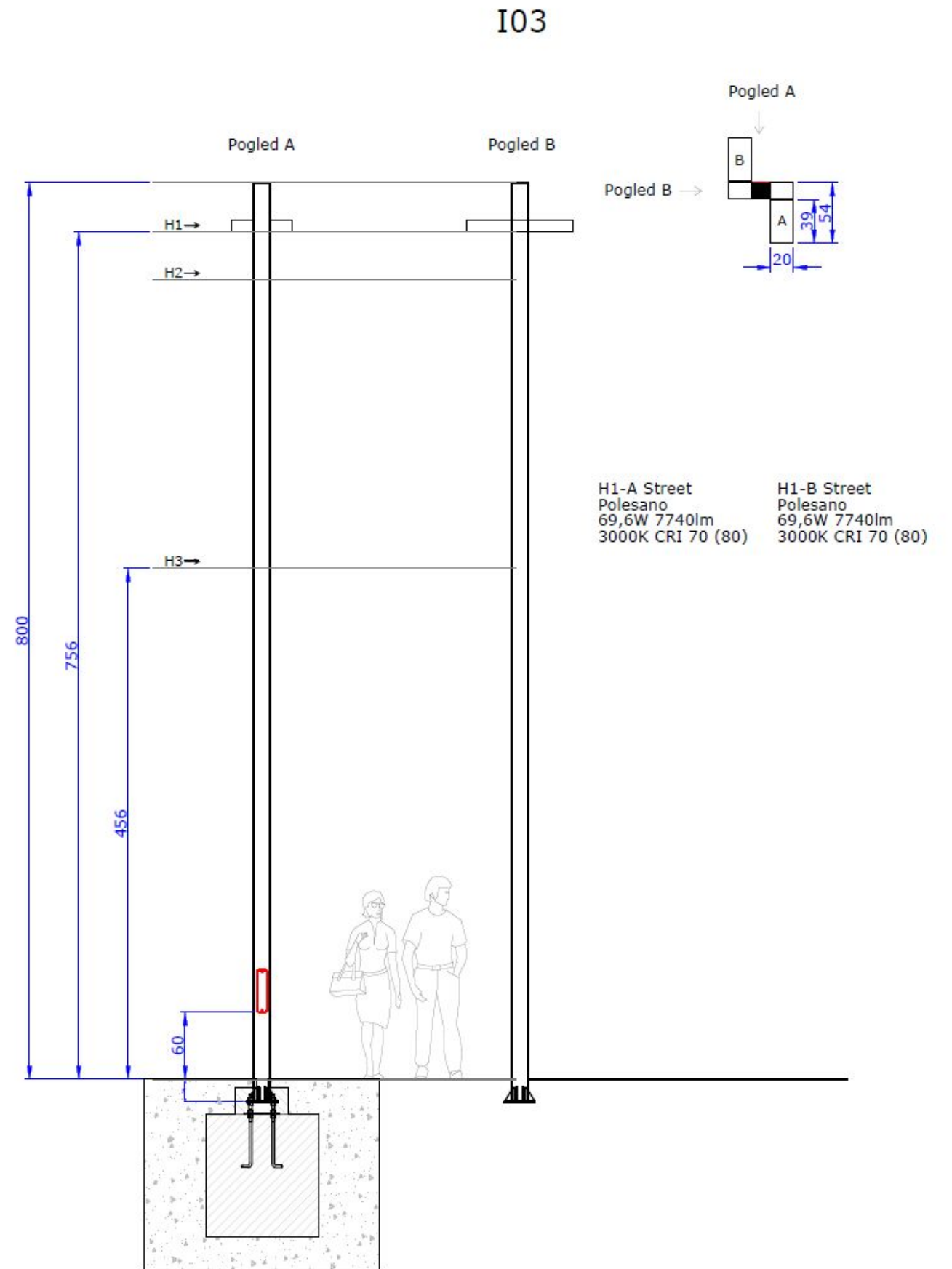

Pogled na  
Giardine iz  
zraka  
—



Pogled iz  
Giardina  
prema  
sjeveru  
—  
postojeće  
stanje



Pogled iz  
Giardina  
prema  
sjeveru  
—



BLHO

Trg 1

—

# Trg 1

—  
Trg palače banke Italije

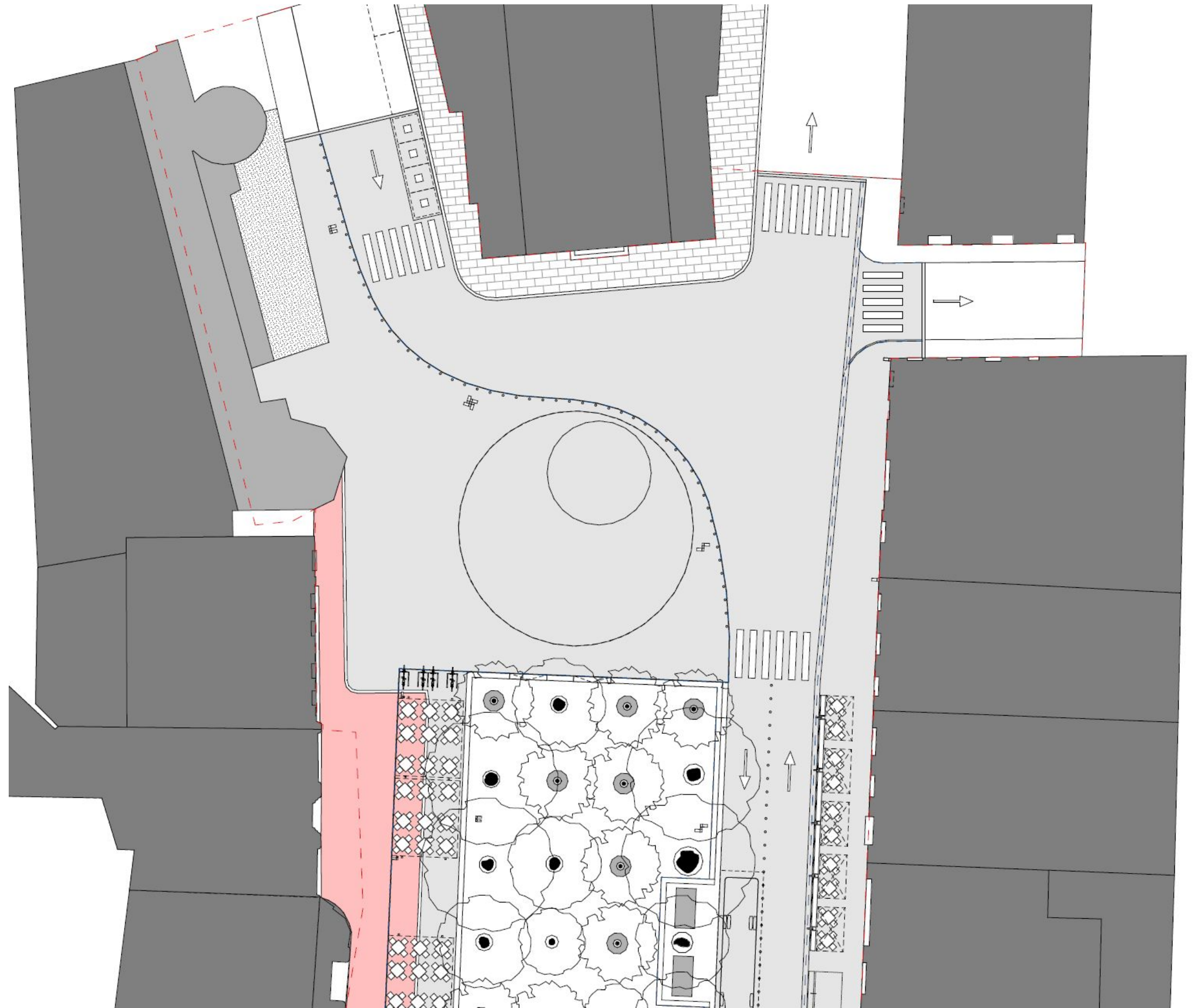
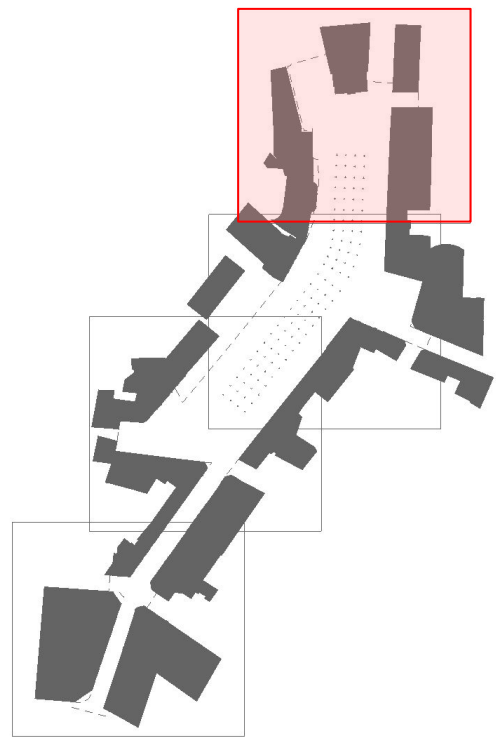

# Atmosfera

—



Pogled na  
ulaz u  
Giardine s  
Trga 1

—





# Pogled na Trg 1 prema Finu

—  
postojeće  
stanje



Pogled na  
Trg 1 prema  
Fini  
—



BLHO

Trg 2

—

Trg 2

—

Trg starog kina

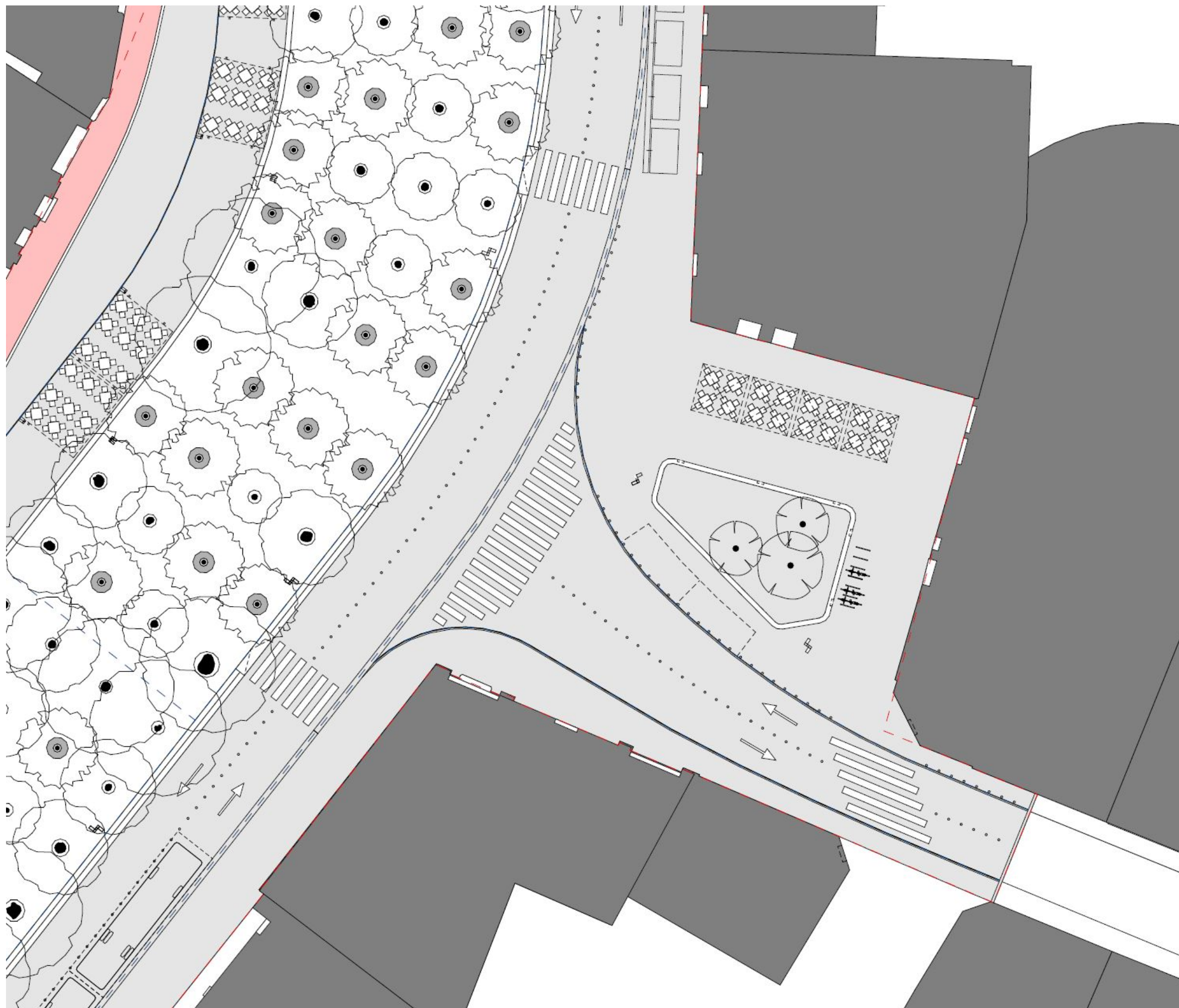
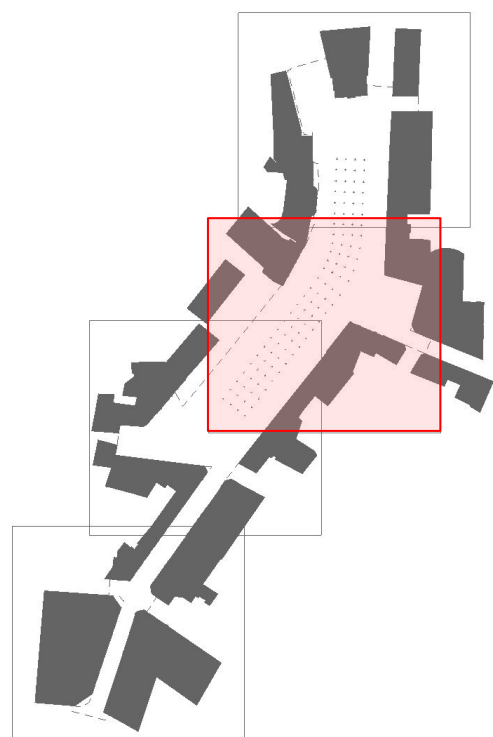

# Atmosfera

—

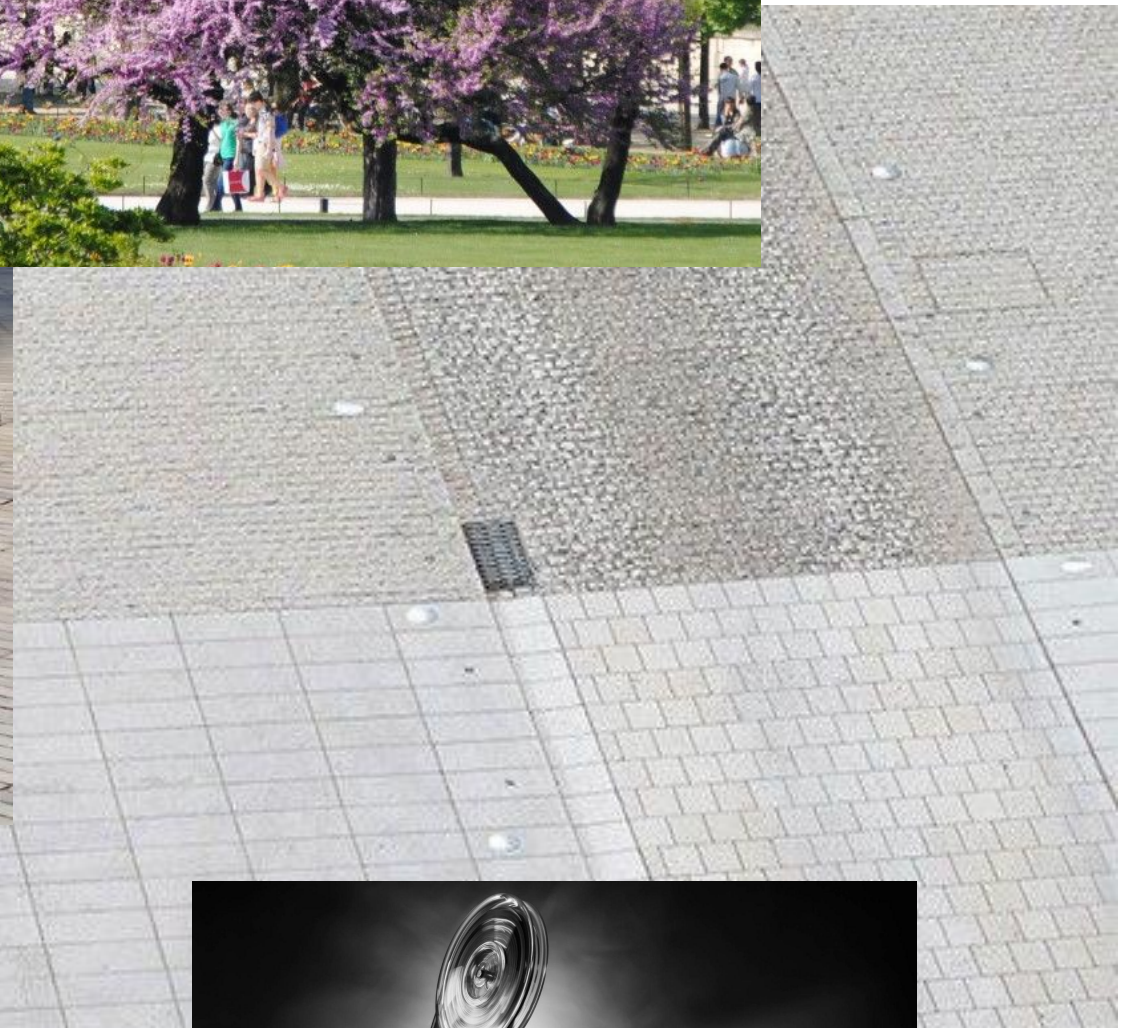

# Pogled na Trg 2 prema starom kinu

—  
postojeće  
stanje



Pogled na  
Trg 2 prema  
starom kinu  
—



BLHO

# Lokali

—



# Lokali

—

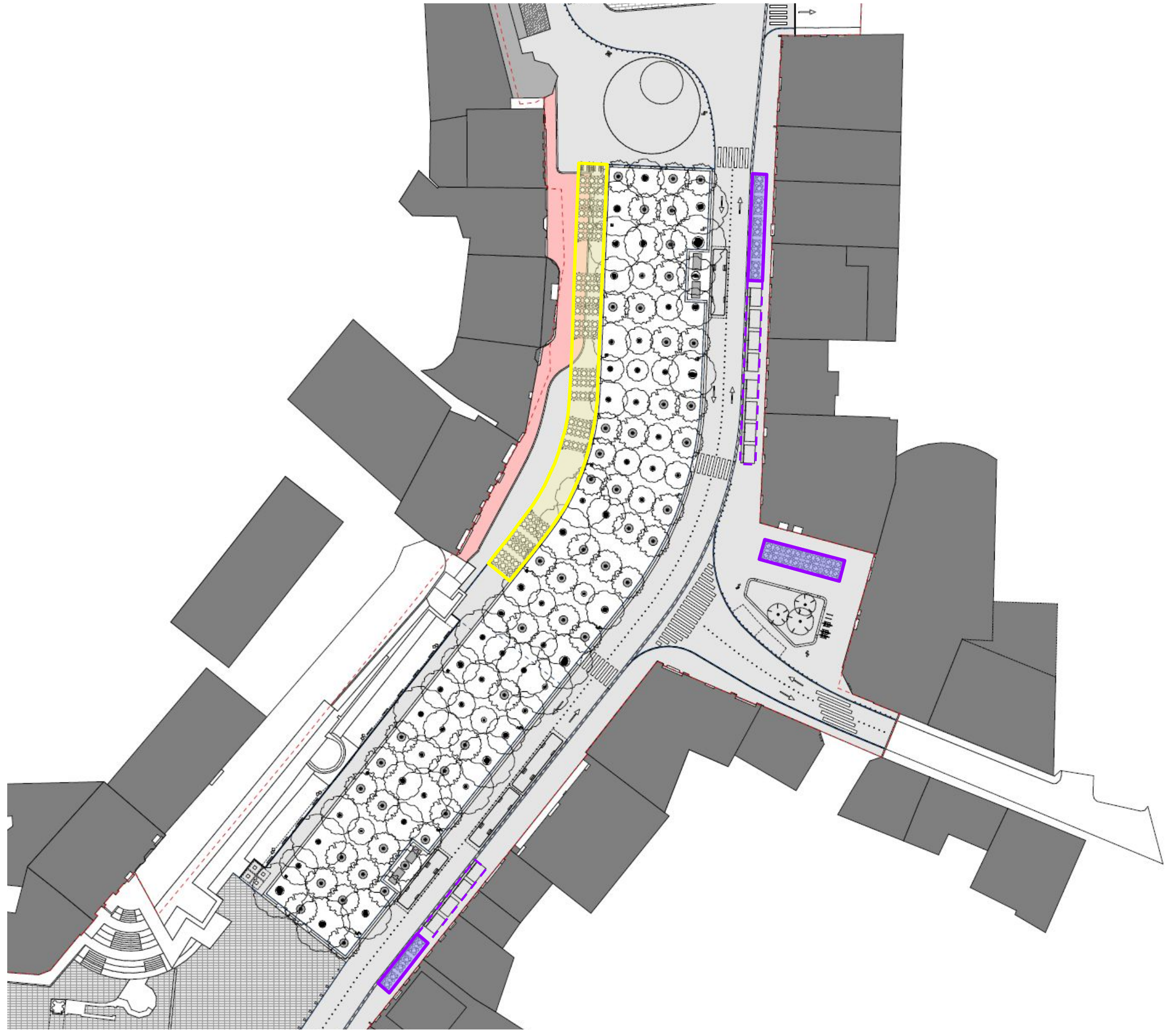
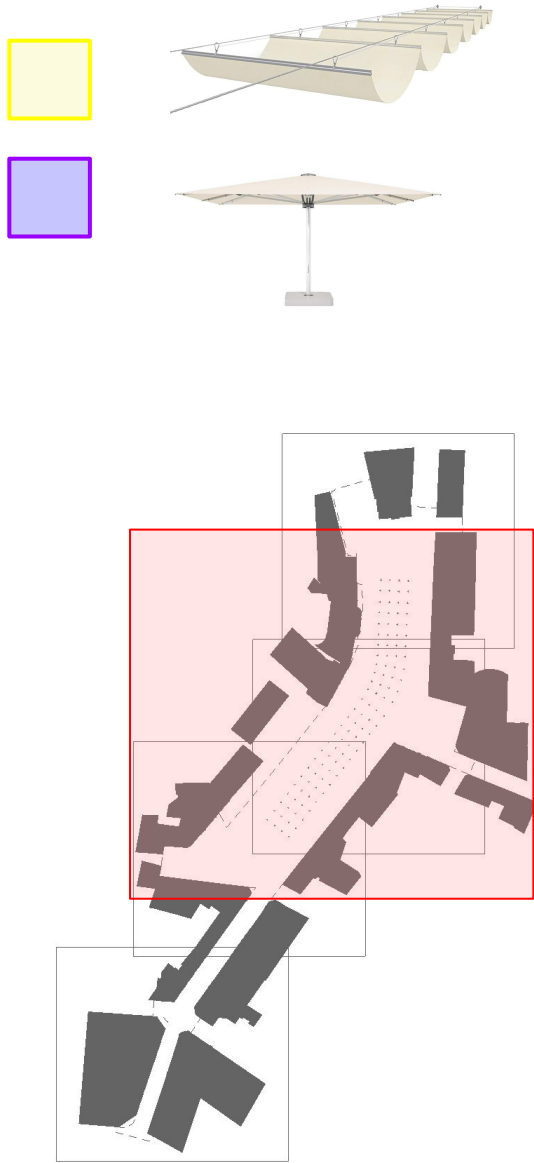

# Atmosfera lokala uz Giardine

—

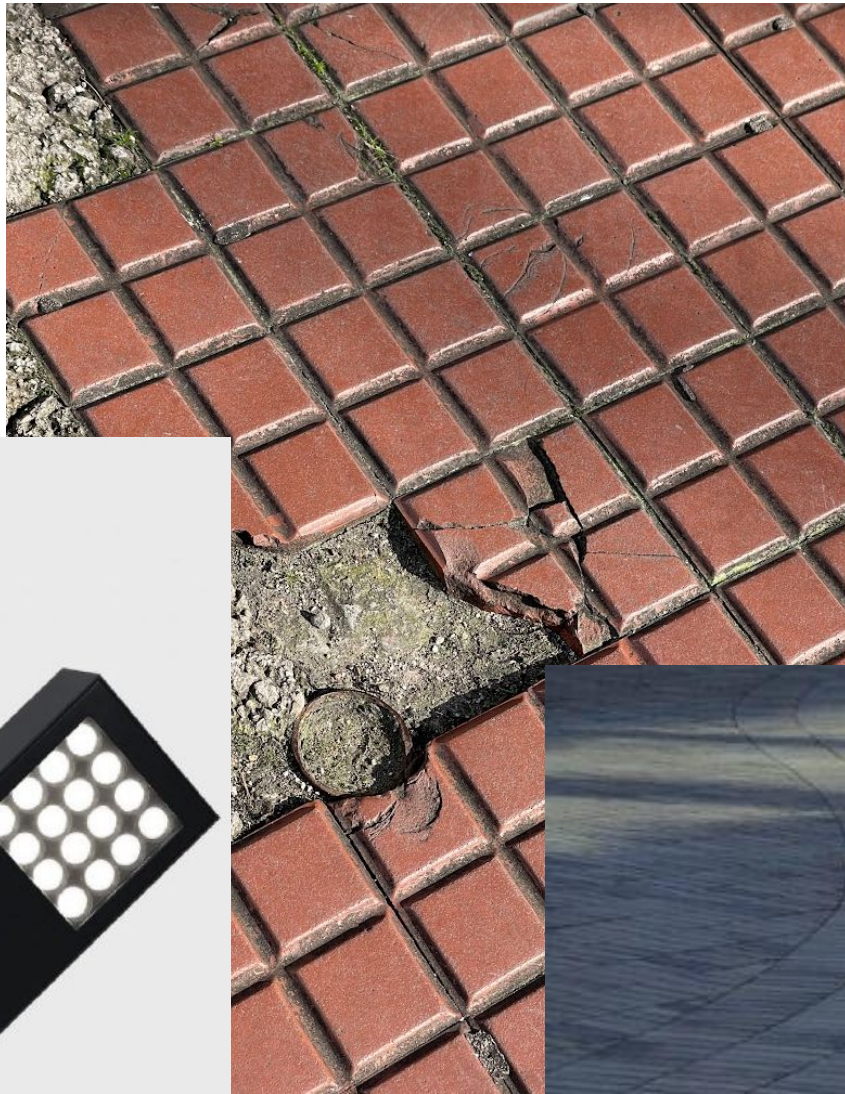

# Atmosfera lokala uz ulicu



Pogled na  
terase lokala  
s Gradskih  
zidina

—  
postojeće  
stanje



Pogled na  
terase lokala  
s Gradskih  
zidina



# Zona arheologije

—

# Detalj šetnice prema Gradskim zidinama

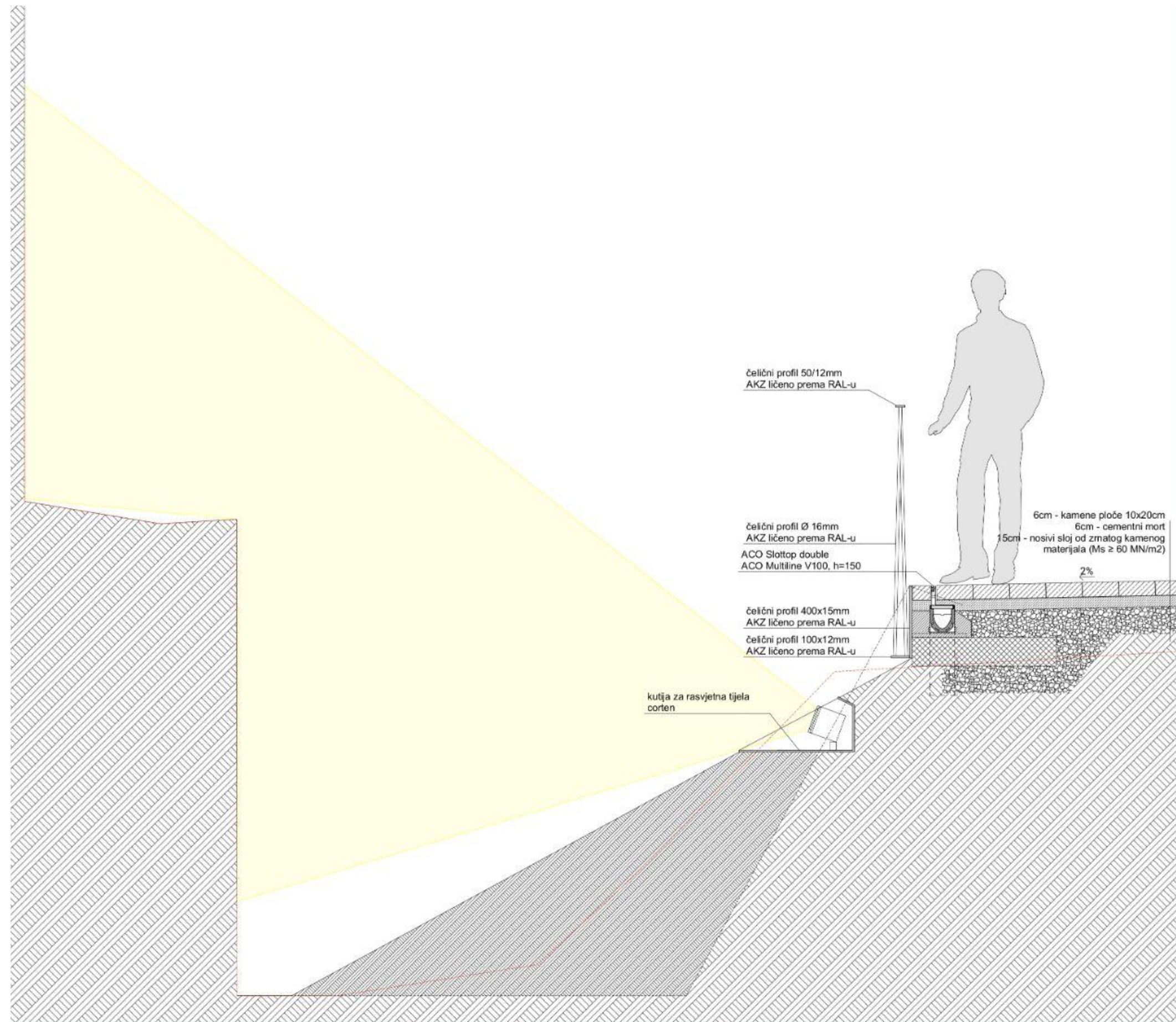
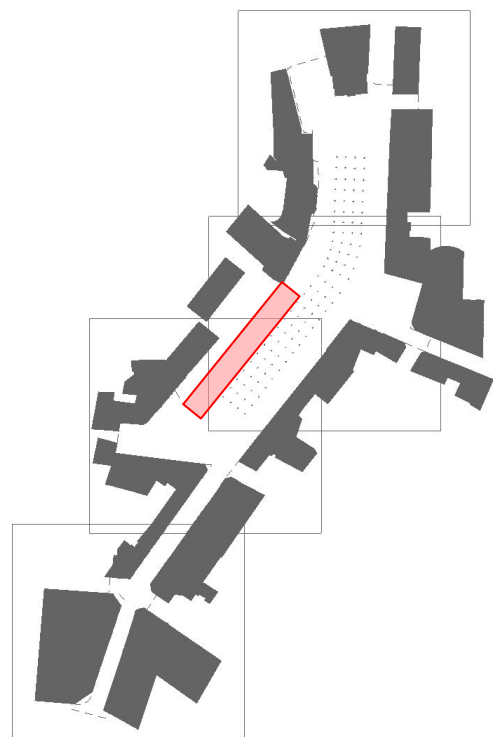

# Atmosfera

—

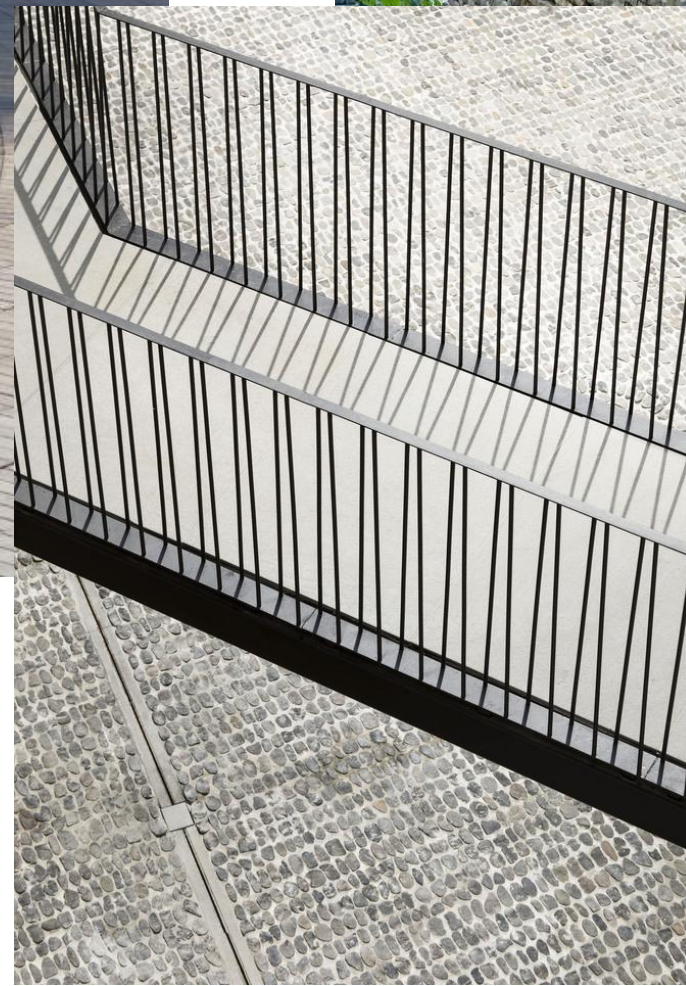
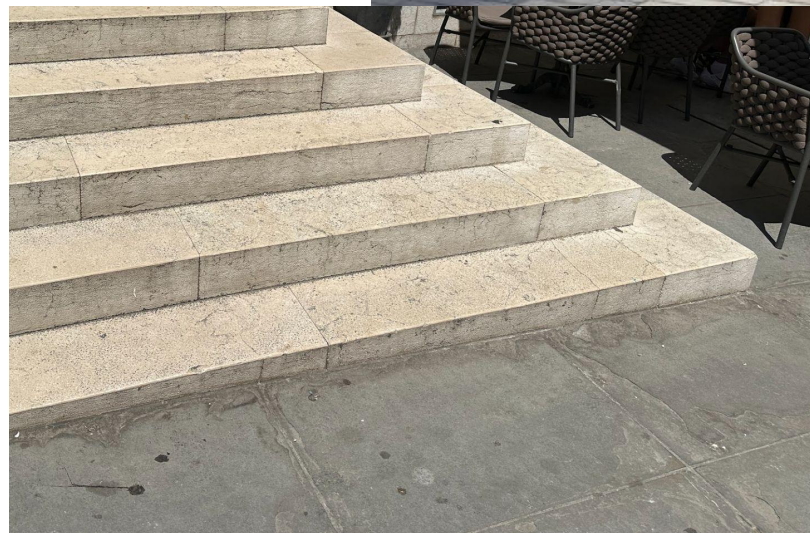



# Pogled iz Giardina prema jugu

—  
postojeće  
stanje



Pogled iz  
Giardina  
prema jugu



BLHO

Laginjina

—

# Laginjina

—

Pješačka zona kao ekstenzija  
Istarskog narodnog kazališta  
prema platou doma hrvatskih  
branitelja

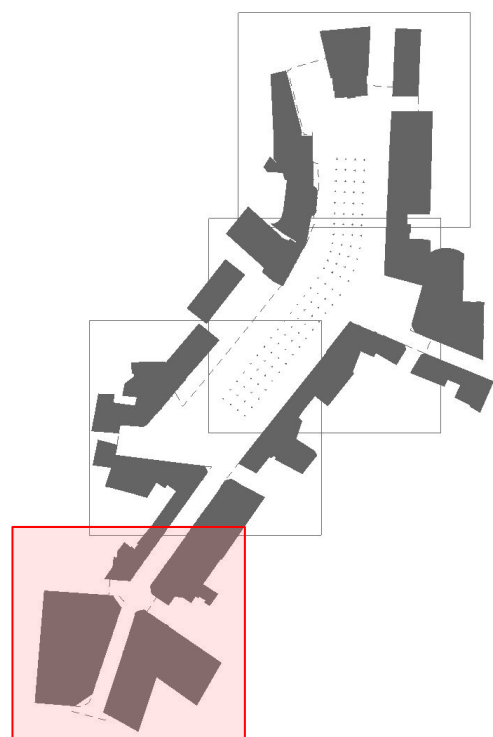

# Prostorni prikazi

—

Pogled na  
Giardine iz  
zraka  
—



Pogled iz  
Giardina  
prema  
sjeveru  
—



Pogled iz  
Giardina  
prema jugu





Pogled na  
terase lokala  
s Gradskih  
zidina



Pogled na  
ulaz u  
Giardine s  
Trga 1

—



Pogled na  
Trg 1 prema  
Fini  
—



Pogled na  
Trg 2 prema  
starom kinu  
—

